

## 8.2 Current Proportional Output Calibration

### Introduction

Calibrate the controller so that the output provides the proper amount of current over the desired range. The controller can provide an output current range of from 2 to 21 milliamperes and can be calibrated at 4 mA for 0% of output and 20 mA for 100% of output, or any other values between 2 and 21 mA.

### Equipment needed

You will need a standard shop type milliammeter, with whatever accuracy is required, capable of measuring 4 to 20 milliamps.

### Calibrator connections

Refer to Figure 8-1 and wire the controller according to the procedure given in Table 8-1.

Table 8-1 Set Up Wiring Procedure Current Proportional Output

Step	Action
1	Apply power and allow the controller to warm up 15 minutes before you calibrate.
2	Set "Lock" in the tuning Set Up group to "None".
3	Tag and disconnect the field wiring, at the rear of the controller, from terminals 4(+) and 5(-), (see Figure 8-1).
4	Connect a milliammeter across these terminals.

Figure 8-1 Wiring Connections for Calibrating Current Proportional Output

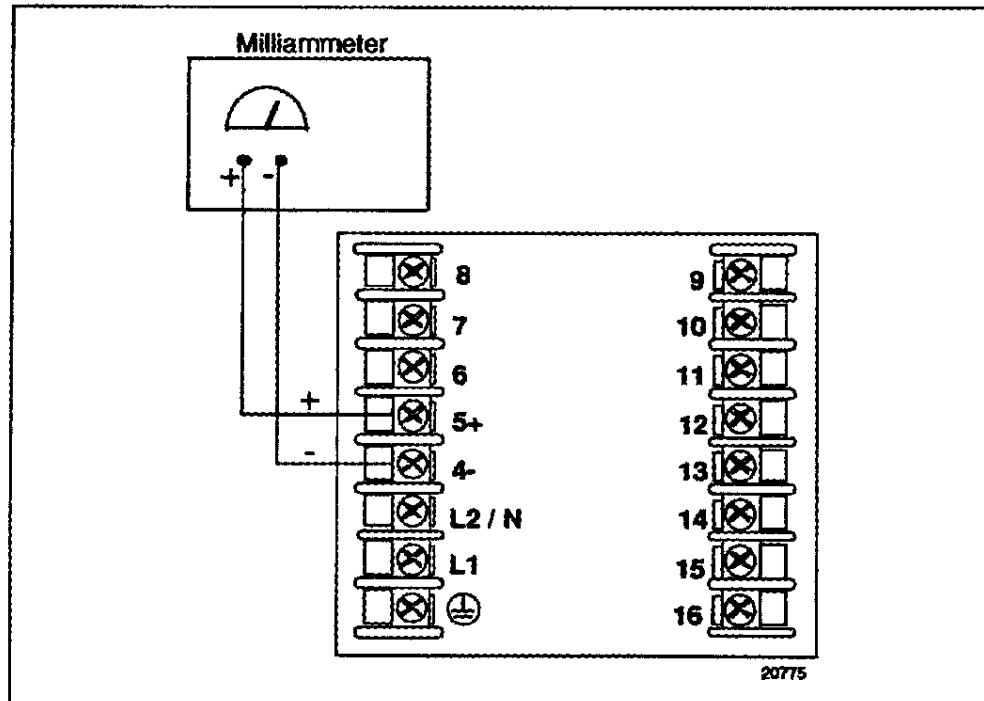











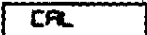

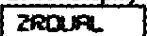

*Continued on next page*

## 8.2 Current Proportional Output Calibration, Continued

### Procedure

The procedure for calibrating the Current Proportional Output is listed in Table 8-2. Make sure "LOCK" in the Tuning Set Up group is set to "NONE" (see *Subsection 3.7 – Tuning Parameters Set Up group*).

Table 8-2 Current Proportional Output Calibration Procedure

Step	Description	Press	Action
1	Enter Calibration Mode	 until you see	Upper Display  Lower Display 
2	Calibrate 0%		You will see: Upper Display  ← a value Lower Display 
		 or 	Until the desired 0% output is read on the milliammeter, use the values shown below depending on the action of your controller. <ul style="list-style-type: none"> <li>• 4 mA For 4 to 20 mA Direct Action</li> <li>• 20 mA For 4 to 20 mA Reverse Action</li> </ul>
3	Calibrate 100%		This stores the 0% value and, You will see: Upper Display  ← a value Lower Display 
		 or 	Until the desired 100% output is read on the milliammeter, use the values shown below depending on the action of your controller. <ul style="list-style-type: none"> <li>• 20 mA For 4 to 20 mA Direct Action</li> <li>• 4 mA For 4 to 20 mA Reverse Action</li> </ul>
4	Exit the Calibration Mode		The controller stores the span value.
			To exit the calibration mode.